

1A LOW NOISE CMOS LDO REGULATOR WITH ENABLE AP2115

General Description

The AP2115 is CMOS process low dropout linear regulator with enable function, the regulator delivers a guaranteed 1A (min.) continuous load current.

The AP2115 features low power consumption.

The AP2115 is available in 1.2V, 1.8V, 2.5V and 3.3V regulator output, and available in excellent output accuracy $\pm 1.5\%$, it is also available in an excellent load regulation and line regulation performance.

The AP2115 is available in standard packages of SOIC-8 and SOT-89-5.

Features

- Output Voltage Accuracy: $\pm 1.5\%$
- Output Current: 1A (Min.)
- Fold-back Short Current Protection: 50mA
- Low Dropout Voltage (3.3V): 450mV (Typ.) @ $I_{OUT}=1A$
- Stable with 4.7 μ F Flexible Cap: Ceramic, Tantalum and Aluminum Electrolytic
- Excellent Line Regulation: 0.02%/V (Typ.), 0.1%/V (Max.) @ $I_{OUT}=30mA$
- Excellent Load Regulation: 0.2%/A @ $I_{OUT}=1mA$ to 1A
- Low Quiescent Current: 60 μ A (1.2V/1.8V/2.5V)
- Low Output Noise: 30 μ V_{RMS}
- PSRR: 68dB @ Freq=1kHz (1.2V/1.8V)
- OTSD Protection
- Operation Temperature Range: -40°C to 85°C
- ESD: MM 400V, HBM 4000V

Applications

- LCD Monitor
- LCD TV
- STB

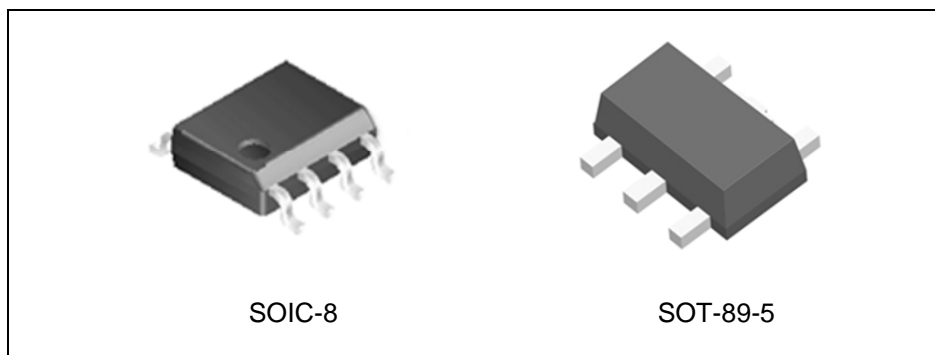
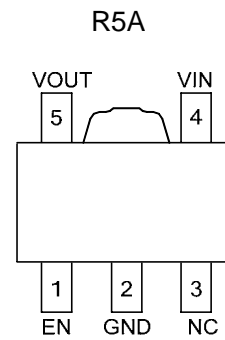
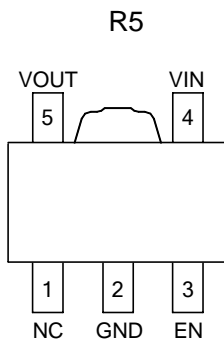

Figure 1. Package Types of AP2115

1A LOW NOISE CMOS LDO REGULATOR WITH ENABLE AP2115

Pin Configuration

R5 Package
(SOT-89-5)



M Package
(SOIC-8)

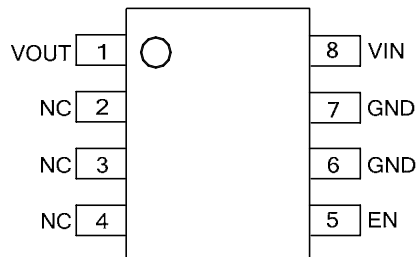

Figure 2. Pin Configuration of AP2115 (Top View)

Pin Descriptions

Pin No.		Name	Function
SOT-89-5	SOIC-8		
1	2, 3, 4	NC/EN	No connection/Chip Enable
2	6, 7	GND	GND
3	5	EN/NC	Chip Enable, H – normal work, L – shutdown output/ No Connection
4	8	VIN	Input Voltage
5	1	VOUT	Output Voltage

1A LOW NOISE CMOS LDO REGULATOR WITH ENABLE AP2115

Functional Block Diagram

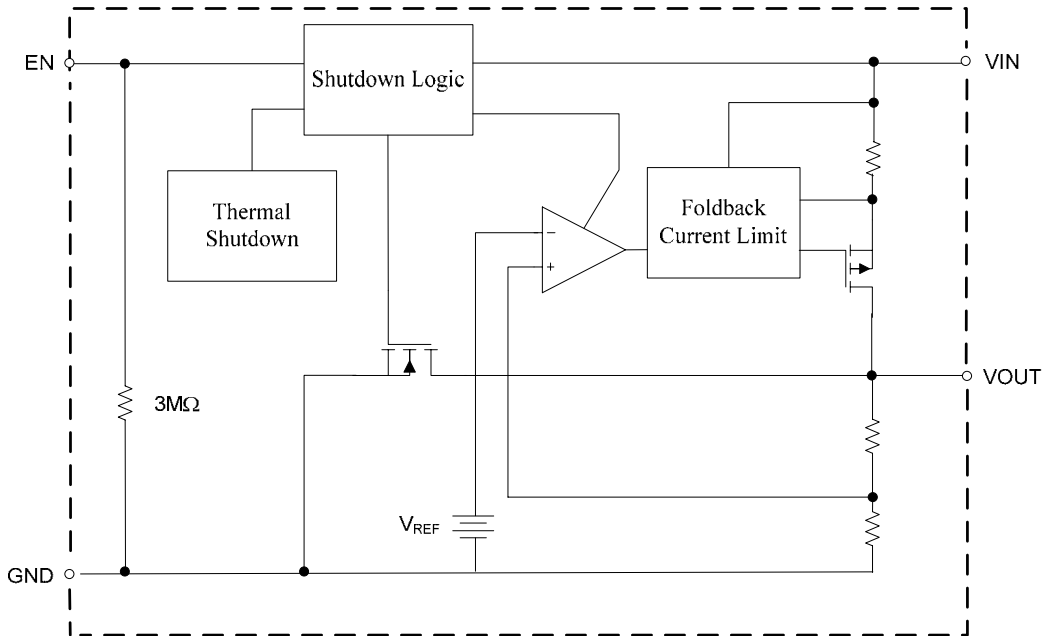
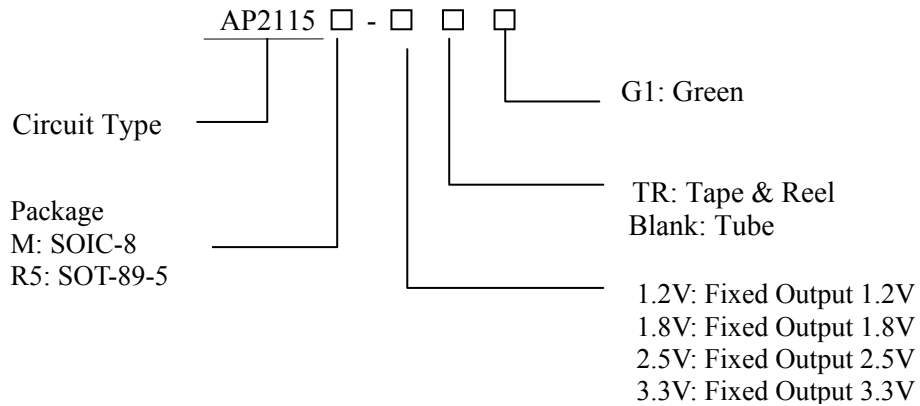

Figure 3. Functional Block Diagram of AP2115

**1A LOW NOISE CMOS LDO REGULATOR WITH ENABLE AP2115****Ordering Information**

Package	Temperature Range	Condition	Part Number	Marking ID	Packing Type
SOIC-8	-40 to 85°C	1.2V	AP2115M-1.2G1	2115M-1.2G1	Tube
			AP2115M-1.2TRG1	2115M-1.2G1	Tape & Reel
		1.8V	AP2115M-1.8G1	2115M-1.8G1	Tube
			AP2115M-1.8TRG1	2115M-1.8G1	Tape & Reel
		2.5V	AP2115M-2.5G1	2115M-2.5G1	Tube
			AP2115M-2.5TRG1	2115M-2.5G1	Tape & Reel
3.3V	AP2115M-3.3G1	2115M-3.3G1	Tube		
	AP2115M-3.3TRG1	2115M-3.3G1	Tape & Reel		
SOT-89-5	-40 to 85°C	1.2V (R5)	AP2115R5-1.2TRG1	G22G	Tape & Reel
		1.8V (R5)	AP2115R5-1.8TRG1	G22H	Tape & Reel
		2.5V (R5)	AP2115R5-2.5TRG1	G37H	Tape & Reel
		3.3V (R5)	AP2115R5-3.3TRG1	G41H	Tape & Reel
SOT-89-5	-40 to 85°C	1.2V (R5A)	AP2115R5A-1.2TRG1	G27D	Tape & Reel
		1.8V (R5A)	AP2115R5A-1.8TRG1	G27G	Tape & Reel
		2.5V (R5A)	AP2115R5A-2.5TRG1	G41F	Tape & Reel
		3.3V (R5A)	AP2115R5A-3.3TRG1	G41G	Tape & Reel

BCD Semiconductor's Pb-free products, as designated with "G1" suffix in the part number, are RoHS compliant and green.

**1A LOW NOISE CMOS LDO REGULATOR WITH ENABLE AP2115****Absolute Maximum Ratings (Note 1)**

Parameter	Symbol	Value	Unit
Power Supply Voltage	V _{CC}	6.5	V
Operating Junction Temperature Range	T _J	150	°C
Storage temperature Range	T _{STG}	-65 to 150	°C
Lead Temperature (Soldering,10 Seconds)	T _{LEAD}	260	°C
ESD (Machine Model)		400	V
ESD (Human Body Model)		4000	V

Note 1: Stresses greater than those listed under “Absolute Maximum Ratings” may cause permanent damage to the device. These are stress ratings only, and functional operation of the device at these or any other conditions beyond those indicated under “Recommended Operating Conditions” is not implied. Exposure to “Absolute Maximum Ratings” for extended periods may affect device reliability.

Recommended Operating Conditions

Parameter	Symbol	Min	Max	Unit
Supply Voltage	V _{IN}	2.5	6.0	V
Ambient Operation Temperature Range	T _A	-40	85	°C



1A LOW NOISE CMOS LDO REGULATOR WITH ENABLE AP2115

Electrical Characteristics

AP2115-1.2 Electrical Characteristics (Note 2)

V_{IN}=2.5V, C_{IN}=4.7μF (Ceramic), C_{OUT}=4.7μF (Ceramic), Typical T_A=25°C, **Bold** typeface applies over -40°C≤T_J≤85°C ranges, unless otherwise specified (Note 3).

Parameter	Symbol	Test Conditions	Min	Typ	Max	Unit
Output Voltage	V _{OUT}	V _{IN} =2.5V, 1mA ≤ I _{OUT} ≤ 30mA	$\frac{V_{OUT}}{\times 98.5\%}$	1.2	$\frac{V_{OUT}}{\times 101.5\%}$	V
Input Voltage	V _{IN}				6	V
Maximum Output Current	I _{OUT(MAX)}	V _{IN} =2.5V, V _{OUT} =1.182V to 1.218V	1			A
Load Regulation	$\frac{\Delta V_{OUT}/V_{OUT}}{\Delta I_{OUT}}$	V _{IN} =2.5V, 1mA ≤ I _{OUT} ≤ 1A		0.2	1	%/A
Line Regulation	$\frac{\Delta V_{OUT}/V_{OUT}}{\Delta V_{IN}}$	2.5V ≤ V _{IN} ≤ 6V, I _{OUT} =30mA	-0.1	0.02	0.1	%/V
Dropout Voltage	V _{DROP}	I _{OUT} =1.0A		1200	1300	mV
Quiescent Current	I _Q	V _{IN} =2.5V, I _{OUT} =0mA		60	75	μA
Power Supply Rejection Ratio	PSRR	Ripple 1Vp-p V _{IN} =2.5V, I _{OUT} =100mA	f=100Hz		68	dB
			f=1KHz		68	
Output Voltage Temperature Coefficient	$\frac{\Delta V_{OUT}/V_{OUT}}{\Delta T}$	I _{OUT} =30mA, T _A = -40°C to 85°C		±30		ppm/°C
Short Current Limit	I _{SHORT}	V _{OUT} =0V		50		mA
RMS Output Noise	V _{NOISE}	10Hz ≤ f ≤ 100kHz (No Load)		30		μV _{RMS}
V _{EN} High Voltage	V _{IH}	Enable logic high, regulator on	1.5			V
V _{EN} Low Voltage	V _{IL}	Enable logic low, regulator off			0.4	
Standby Current	I _{STD}	V _{IN} =3.5V, V _{EN} in OFF mode		0.01	1.0	μA
Start-up Time	t _S	No Load		20		μs
EN Pull Down Resistor	R _{PD}			3.0		MΩ
V _{OUT} Discharge Resistor	R _{DCHG}	Set EN pin at Low		60		Ω
Thermal Shutdown Temperature	T _{OTSD}			160		°C
Thermal Shutdown Hysteresis	T _{HYOTSD}			25		
Thermal Resistance	θ _{JC}	SOIC-8		74.6		°C/W
		SOT-89-5		47		

Note 2: To prevent the Short Circuit Current protection feature from being prematurely activated, the input voltage must be applied before a current source load is applied.

Note 3: Production testing at T_A=25°C. Over temperature specifications guaranteed by design only.



1A LOW NOISE CMOS LDO REGULATOR WITH ENABLE AP2115

Electrical Characteristics (Continued)

AP2115-1.8 Electrical Characteristics (Note 2)

V_{IN}=2.8V, C_{IN}=4.7μF (Ceramic), C_{OUT}=4.7μF (Ceramic), Typical T_A=25°C, **Bold** typeface applies over -40°C≤T_J≤85°C ranges, unless otherwise specified (Note 3).

Parameter	Symbol	Test Conditions	Min	Typ	Max	Unit
Output Voltage	V _{OUT}	V _{IN} =2.8V, 1mA ≤ I _{OUT} ≤ 30mA	98.5% ×V _{OUT}	1.8	101.5% ×V _{OUT}	V
Maximum Output Current	I _{OUT(MAX)}	V _{IN} =2.8V, V _{OUT} =1.773V to 1.827V	1			A
Load Regulation	$\frac{\Delta V_{OUT}/V_{OUT}}{\Delta I_{OUT}}$	V _{IN} =2.8V, 1mA ≤ I _{OUT} ≤ 1A		0.2	1	%/A
Line Regulation	$\frac{\Delta V_{OUT}/V_{OUT}}{\Delta V_{IN}}$	2.8V ≤ V _{IN} ≤ 6V, I _{OUT} =30mA	-0.1	0.02	0.1	%/V
Dropout Voltage	V _{DROP}	I _{OUT} =1.0A		500	750	mV
Quiescent Current	I _Q	V _{IN} =2.8V, I _{OUT} =0mA		60	75	μA
Power Supply Rejection Ratio	PSRR	Ripple 1Vp-p V _{IN} =2.8V, I _{OUT} =100mA	f=100Hz		68	dB
			f=1KHz		68	
Output Voltage Temperature Coefficient	$\frac{\Delta V_{OUT}/V_{OUT}}{\Delta T}$	I _{OUT} =30mA, T _A = -40°C to 85°C		±30		ppm/°C
Short Current Limit	I _{SHORT}	V _{OUT} =0V		50		mA
RMS Output Noise	V _{NOISE}	10Hz ≤ f ≤ 100kHz (No load)		30		μV _{RMS}
V _{EN} High Voltage	V _{IH}	Enable logic high, regulator on	1.5			V
V _{EN} Low Voltage	V _{IL}	Enable logic low, regulator off			0.4	
Standby Current	I _{STD}	V _{IN} =3.5V, V _{EN} in OFF mode		0.01	1.0	μA
Start-up Time	t _S	No Load		20		μs
EN Pull Down Resistor	R _{PD}			3.0		MΩ
V _{OUT} Discharge Resistor	R _{DCHG}	Set EN pin at Low		60		Ω
Thermal Shutdown Temperature	T _{OTSD}			160		°C
Thermal Shutdown Hysteresis	T _{HYOTSD}			25		
Thermal Resistance	θ _{JC}	SOIC-8		74.6		°C/W
		SOT-89-5		47		

Note 2: To prevent the Short Circuit Current protection feature from being prematurely activated, the input voltage must be applied before a current source load is applied.

Note 3: Production testing at T_A=25°C. Over temperature specifications guaranteed by design only.



1A LOW NOISE CMOS LDO REGULATOR WITH ENABLE AP2115

Electrical Characteristics (Continued)

AP2115-2.5 Electrical Characteristics (Note 2)

V_{IN}=3.5V, C_{IN}=4.7μF (Ceramic), C_{OUT}=4.7μF (Ceramic), Typical T_A=25°C, **Bold** typeface applies over -40°C≤T_J≤85°C ranges, unless otherwise specified (Note 3).

Parameter	Symbol	Test Conditions	Min	Typ	Max	Unit
Output Voltage	V _{OUT}	V _{IN} =3.5V, 1mA ≤ I _{OUT} ≤ 30mA	98.5% ×V _{OUT}	2.5	101.5% ×V _{OUT}	V
Maximum Output Current	I _{OUT(MAX)}	V _{IN} =3.5V, V _{OUT} =2.463V to 2.537V	1			A
Load Regulation	$\frac{\Delta V_{OUT}/V_{OUT}}{\Delta I_{OUT}}$	V _{OUT} =2.5V, V _{IN} =V _{OUT} +1V 1mA ≤ I _{OUT} ≤ 1A		0.2	1	%/A
Line Regulation	$\frac{\Delta V_{OUT}/V_{OUT}}{\Delta V_{IN}}$	3.5V ≤ V _{IN} ≤ 6V, I _{OUT} =30mA	-0.1	0.02	0.1	%/V
Dropout Voltage	V _{DROP}	I _{OUT} =1A		450	750	mV
Quiescent Current	I _Q	V _{IN} =3.5V, I _{OUT} =0mA		60	80	μA
Standby Current	I _{STD}	V _{IN} =3.5V, V _{EN} in OFF mode		0.01	1.0	μA
Power Supply Rejection Ratio	PSRR	Ripple 1Vp-p V _{IN} =3.5V, I _{OUT} =100mA	f=100Hz	65		dB
			f=1KHz	65		
Output Voltage Temperature Coefficient	$\frac{\Delta V_{OUT}/V_{OUT}}{\Delta T}$	I _{OUT} =30mA		±30		ppm/°C
Short Current Limit	I _{SHORT}	V _{OUT} =0V		50		mA
RMS Output Noise	V _{NOISE}	10Hz ≤ f ≤ 100kHz		30		μV _{RMS}
V _{EN} High Voltage	V _{IH}	Enable logic high, regulator on	1.5			V
V _{EN} Low Voltage	V _{IL}	Enable logic low, regulator off			0.4	
Start-up Time	t _S	No Load		20		μs
EN Pull Down Resistor	R _{PD}			3.0		MΩ
V _{OUT} Discharge Resistor	R _{DCHG}	Set EN pin at Low		60		Ω
Thermal Shutdown Temperature	T _{OTSD}			160		°C
Thermal Shutdown Hysteresis	T _{HYOTSD}			25		
Thermal Resistance	θ _{JC}	SOIC-8		74.6		°C/W
		SOT-89-5		47		

Note 2: To prevent the Short Circuit Current protection feature from being prematurely activated, the input voltage must be applied before a current source load is applied.

Note 3: Production testing at T_A=25°C. Over temperature specifications guaranteed by design only.



1A LOW NOISE CMOS LDO REGULATOR WITH ENABLE AP2115

Electrical Characteristics (Continued)

AP2115-3.3 Electrical Characteristics (Note 2)

V_{IN}=4.3V, C_{IN}=4.7μF (Ceramic), C_{OUT}=4.7μF (Ceramic), Typical T_A=25°C, **Bold** typeface applies over -40°C≤T_J≤85°C ranges, unless otherwise specified (Note 3).

Parameter	Symbol	Test Conditions	Min	Typ	Max	Unit
Output Voltage	V _{OUT}	V _{IN} =4.3V, 1mA ≤ I _{OUT} ≤ 30mA	98.5% ×V _{OUT}	3.3	101.5% ×V _{OUT}	V
Maximum Output Current	I _{OUT(MAX)}	V _{IN} =4.3V, V _{OUT} =3.25V to 3.35V	1			A
Load Regulation	$\frac{\Delta V_{OUT}/V_{OUT}}{\Delta I_{OUT}}$	V _{IN} =4.3V, 1mA ≤ I _{OUT} ≤ 1A		0.2	1	%/A
Line Regulation	$\frac{\Delta V_{OUT}/V_{OUT}}{\Delta V_{IN}}$	4.3V ≤ V _{IN} ≤ 6V, I _{OUT} =30mA	-0.1	0.02	0.1	%/V
Dropout Voltage	V _{DROP}	I _{OUT} =1A		450	750	mV
Quiescent Current	I _Q	V _{IN} =4.3V, I _{OUT} =0mA		65	90	μA
Power Supply Rejection Ratio	PSRR	Ripple 1Vp-p V _{IN} =4.3V, I _{OUT} =100mA	f=100Hz	65		dB
			f=1KHz	65		
Output Voltage Temperature Coefficient	$\frac{\Delta V_{OUT}/V_{OUT}}{\Delta T}$	I _{OUT} =30mA		±30		ppm/°C
Short Current Limit	I _{SHORT}	V _{OUT} =0V		50		mA
RMS Output Noise	V _{NOISE}	10Hz ≤ f ≤ 100kHz (No load)		30		μV _{RMS}
V _{EN} High Voltage	V _{IH}	Enable logic high, regulator on	1.5			V
V _{EN} Low Voltage	V _{IL}	Enable logic low, regulator off			0.4	
Standby Current	I _{STD}	V _{IN} =3.5V, V _{EN} in OFF mode		0.01	1.0	μA
Start-up Time	t _S	No Load		20		μs
EN Pull Down Resistor	R _{PD}			3.0		MΩ
V _{OUT} Discharge Resistor	R _{DCHG}	Set EN pin at Low		60		Ω
Thermal Shutdown Temperature	T _{OTSD}			160		°C
Thermal Shutdown Hysteresis	T _{HYOTSD}			25		
Thermal Resistance	θ _{JC}	SOIC-8		74.6		°C/W
		SOT-89-5		47		

Note 2: To prevent the Short Circuit Current protection feature from being prematurely activated, the input voltage must be applied before a current source load is applied.

Note 3: Production testing at T_A=25°C. Over temperature specifications guaranteed by design only.



1A LOW NOISE CMOS LDO REGULATOR WITH ENABLE AP2115

Typical Performance Characteristics

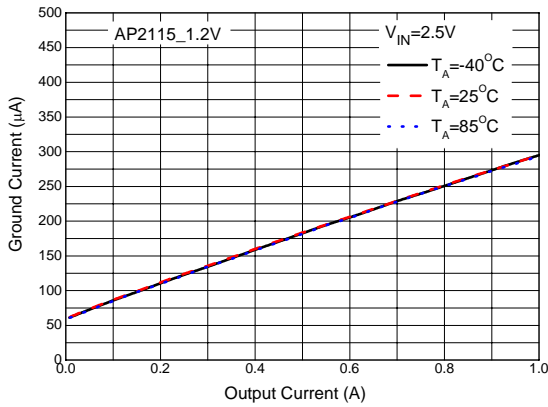

Figure 4. Ground Current vs. Output Current

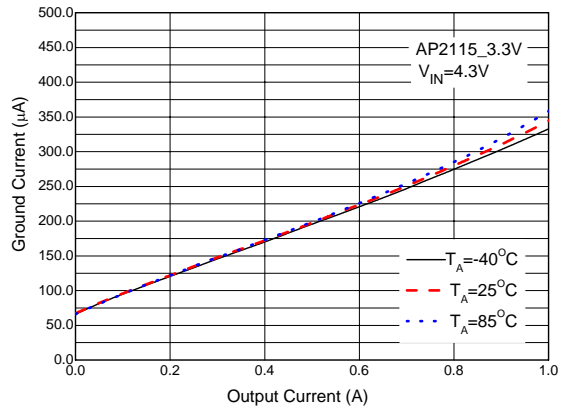

Figure 5. Ground Current vs. Output Current

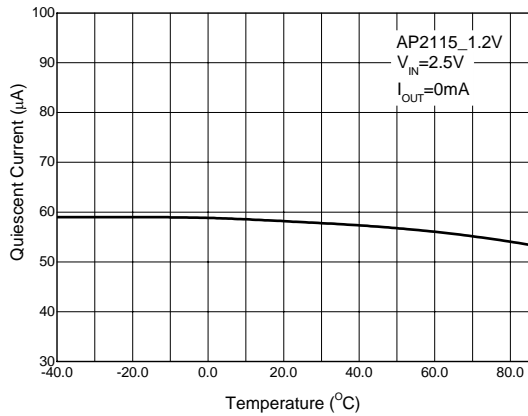

Figure 6. Quiescent Current vs. Temperature

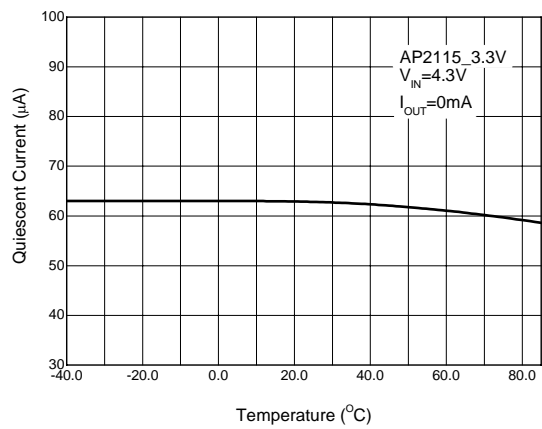

Figure 7. Quiescent Current vs. Temperature



1A LOW NOISE CMOS LDO REGULATOR WITH ENABLE AP2115

Typical Performance Characteristics (Continued)

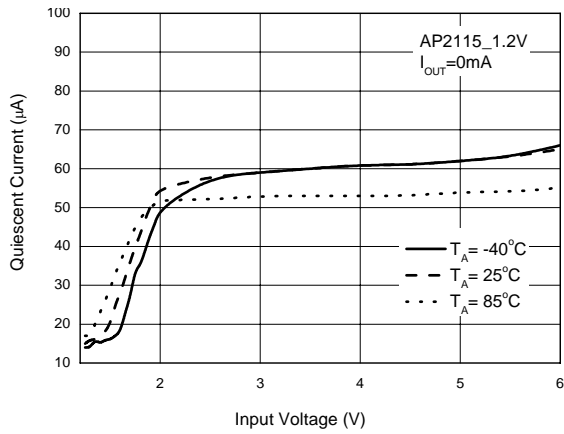

Figure 8. Quiescent Current vs. Input Voltage

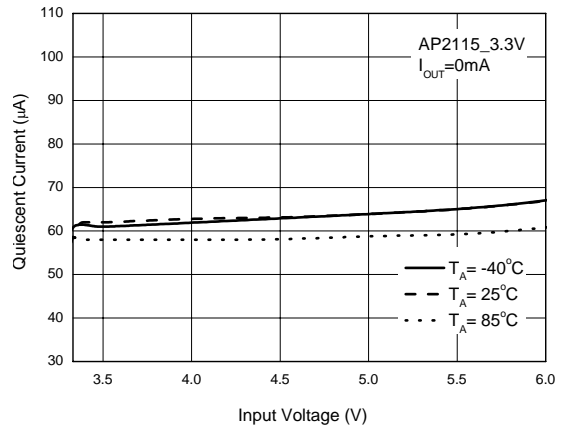

Figure 9. Quiescent Current vs. Input Voltage

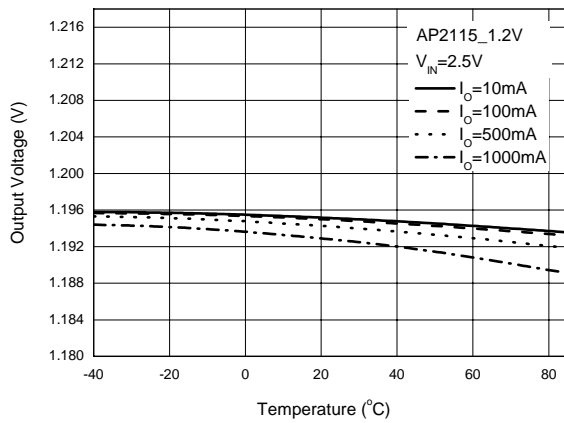

Figure 10. Output Voltage vs. Temperature

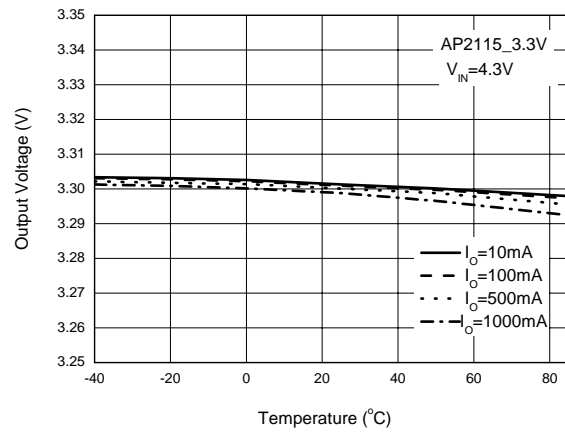

Figure 11. Output Voltage vs. Temperature



1A LOW NOISE CMOS LDO REGULATOR WITH ENABLE AP2115

Typical Performance Characteristics (Continued)

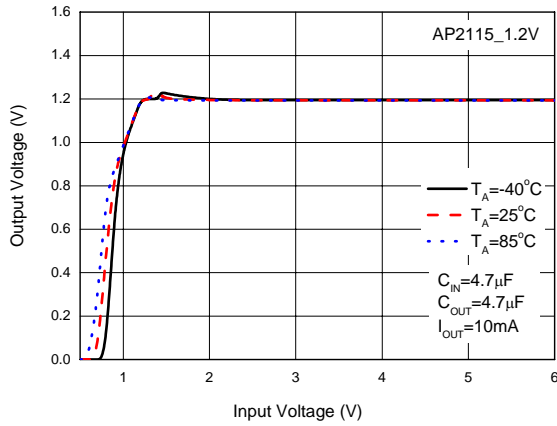

Figure 12. Output Voltage vs. Input Voltage

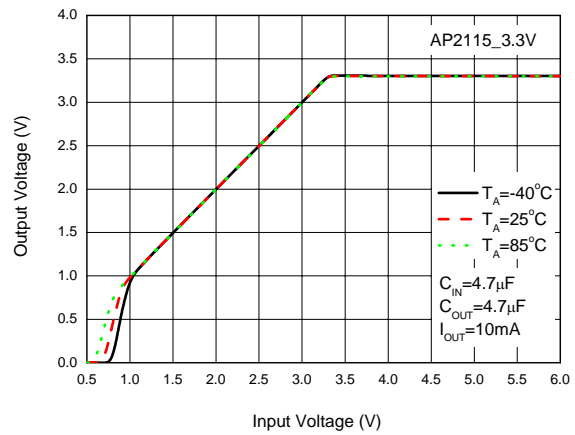

Figure 13. Output Voltage vs. Input Voltage

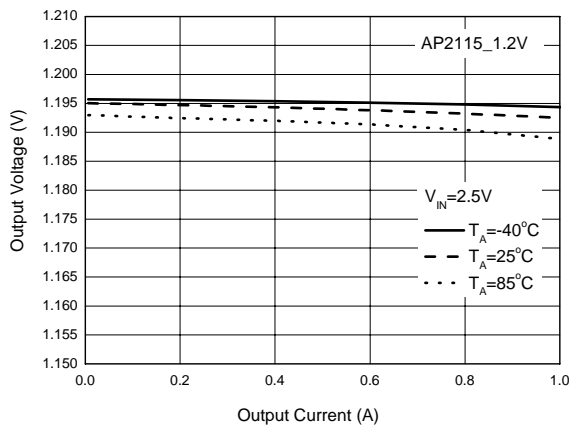

Figure 14. Output Voltage vs. Output Current

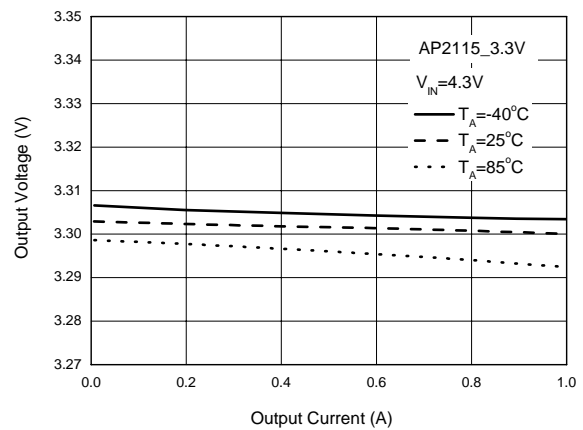

Figure 15. Output Voltage vs. Output Current



1A LOW NOISE CMOS LDO REGULATOR WITH ENABLE AP2115

Typical Performance Characteristics (Continued)

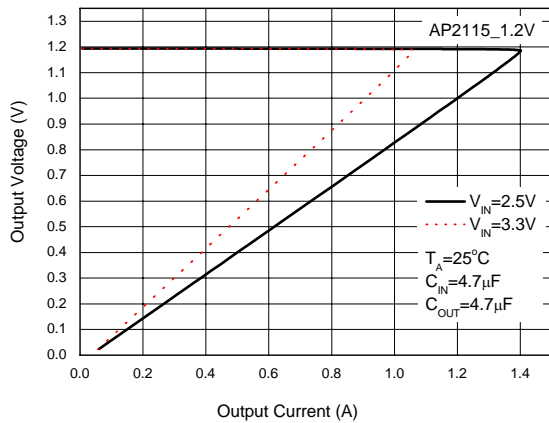

Figure 16. Output Voltage vs. Output Current

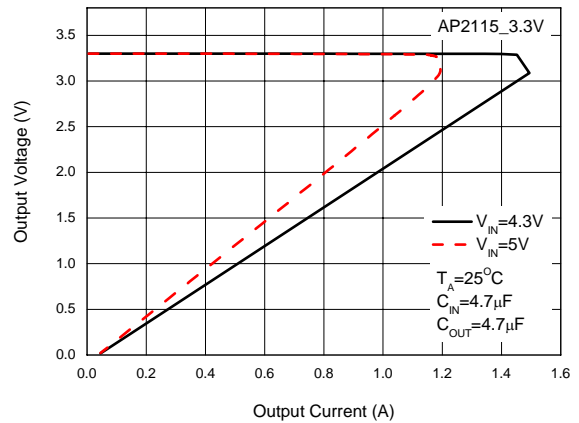

Figure 17. Output Voltage vs. Output Current

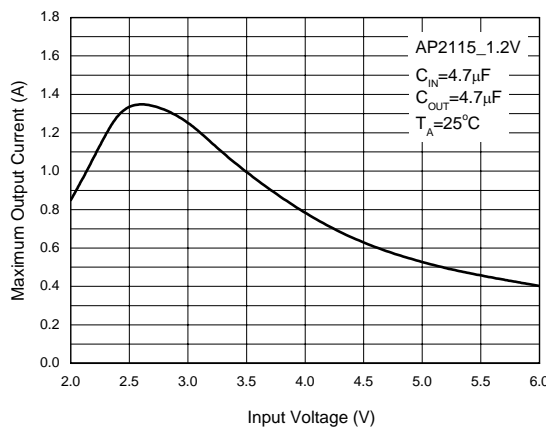

Figure 18. Maximum Output Current vs. Input Voltage

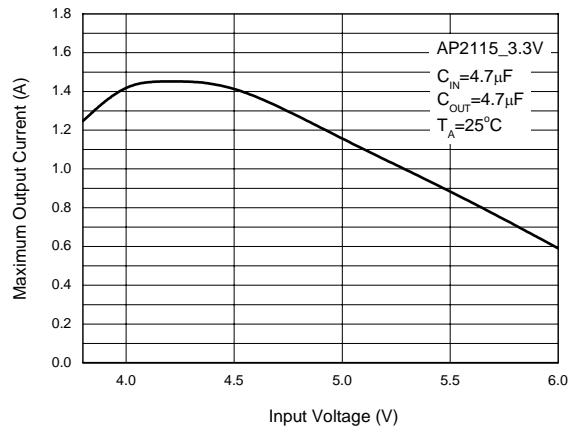

Figure 19. Maximum Output Current vs. Input Voltage



1A LOW NOISE CMOS LDO REGULATOR WITH ENABLE AP2115

Typical Performance Characteristics (Continued)

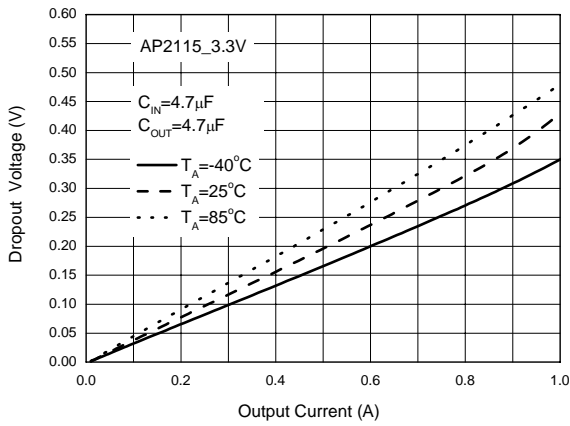

Figure 20. Dropout Voltage vs. Output Current

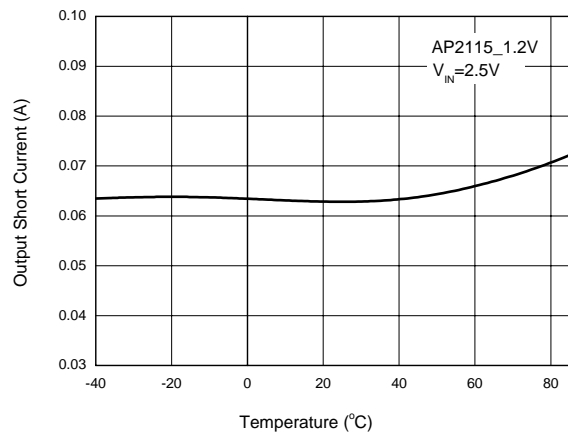

Figure 21. Output Short Current vs. Temperature

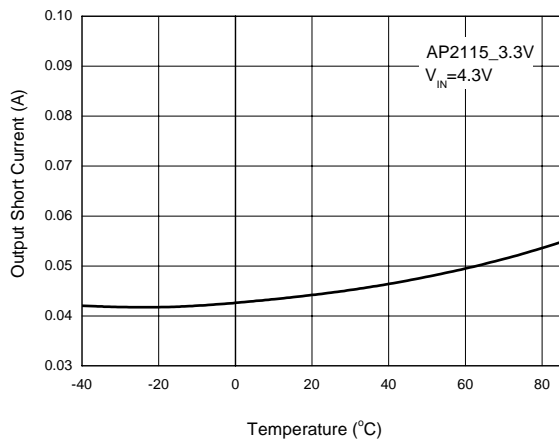

Figure 22. Output Short Current vs. Temperature

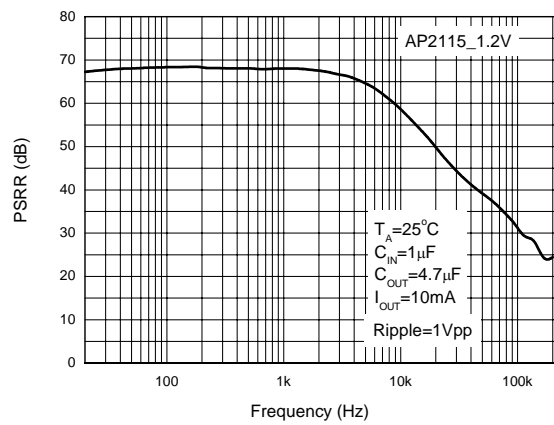

Figure 23. PSRR vs. Frequency

1A LOW NOISE CMOS LDO REGULATOR WITH ENABLE AP2115

Typical Performance Characteristics (Continued)

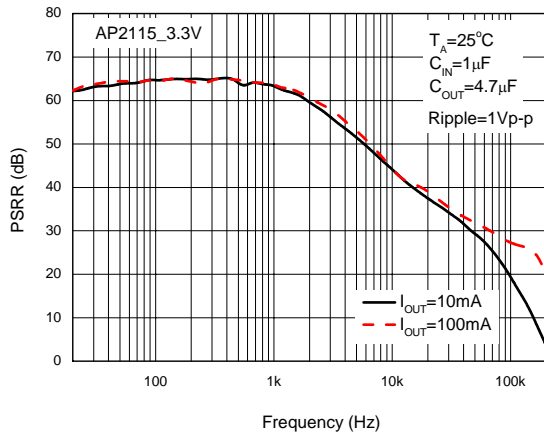

Figure 24. PSRR vs. Frequency

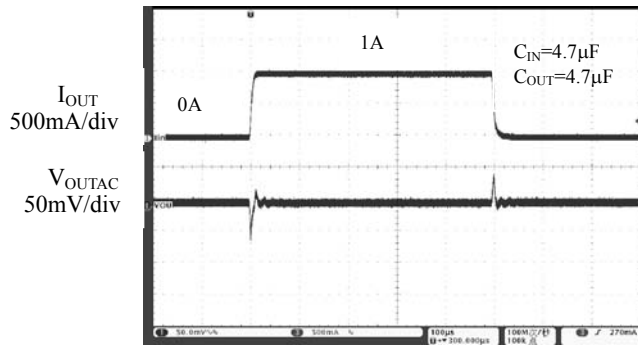

Figure 25. Load Transient

1A LOW NOISE CMOS LDO REGULATOR WITH ENABLE AP2115**Typical Application**

Figure 26. AP2115 Typical Application



1A LOW NOISE CMOS LDO REGULATOR WITH ENABLE AP2115

Mechanical Dimensions (Continued)

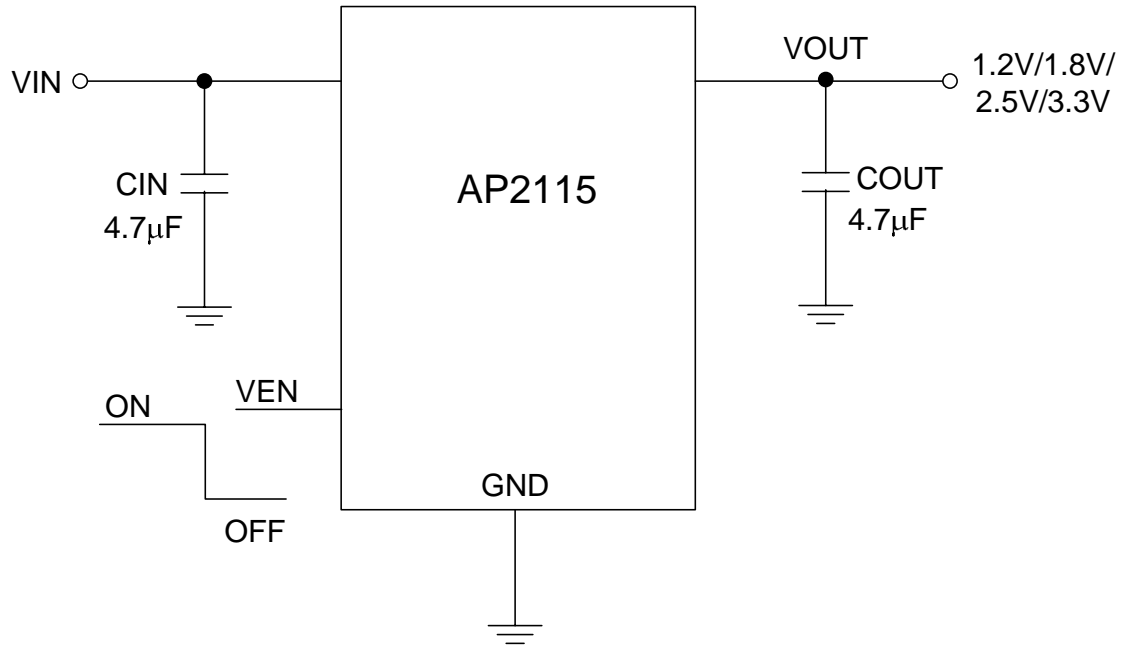
SOT-89-5

Unit: mm(inch)

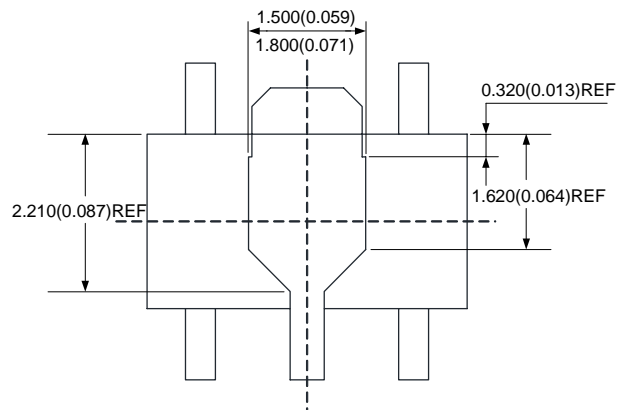
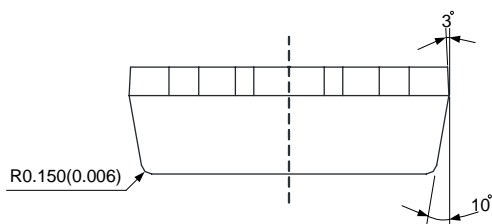
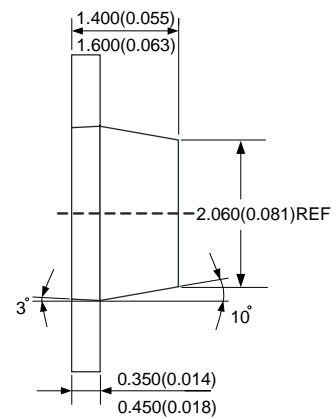
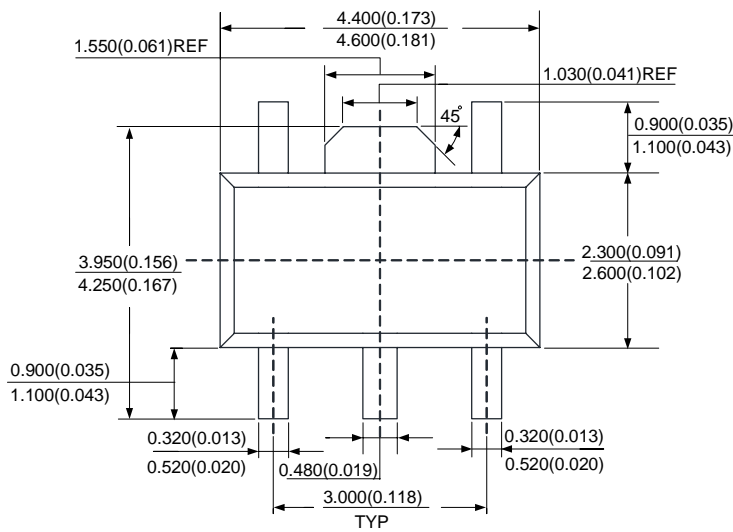



BCD Semiconductor Manufacturing Limited

<http://www.bcdsemi.com>

IMPORTANT NOTICE

BCD Semiconductor Manufacturing Limited reserves the right to make changes without further notice to any products or specifications herein. BCD Semiconductor Manufacturing Limited does not assume any responsibility for use of any its products for any particular purpose, nor does BCD Semiconductor Manufacturing Limited assume any liability arising out of the application or use of any its products or circuits. BCD Semiconductor Manufacturing Limited does not convey any license under its patent rights or other rights nor the rights of others.

MAIN SITE

- Headquarters

BCD Semiconductor Manufacturing Limited

No. 1600, Zi Xing Road, Shanghai ZiZhu Science-based Industrial Park, 200241, China
Tel: +86-21-24162266, Fax: +86-21-24162277

- Wafer Fab

Shanghai SIM-BCD Semiconductor Manufacturing Co., Ltd.

800 Yi Shan Road, Shanghai 200233, China
Tel: +86-21-6485 1491, Fax: +86-21-5450 0008

REGIONAL SALES OFFICE

Shenzhen Office

Shanghai SIM-BCD Semiconductor Manufacturing Co., Ltd., Shenzhen Office

Unit A Room 1203, Skyworth Bldg., Gaoxin Ave. 1.S., Nanshan District, Shenzhen, China
Tel: +86-755-8826 7951
Fax: +86-755-8826 7865

Taiwan Office

BCD Semiconductor (Taiwan) Company Limited

4F, 298-1, Rui Guang Road, Nei-Hu District, Taipei, Taiwan
Tel: +886-2-2656 2808
Fax: +886-2-2656 2806

USA Office

BCD Semiconductor Corp.

30920 Huntwood Ave. Hayward, CA 94544, USA
Tel : +1-510-324-2988
Fax: +1-510-324-2788